

Service manual

Deck oven Ebo 124 M 400V 50Hz

Version: 2.00

Ident:

Series:

Part-Number: X1640

This part can be ordered.

Chapter

Baking chamber Ebo 124 M 400V 50Hz - V:

Control Ebo 124 M 400V 50Hz - V:

Door Ebo 124 M 400V 50Hz - V:

X1640-500-000 - Frame Ebo 124 M 400V 50Hz - V:

Heater Ebo 124 M 400V 50Hz - V:

Installation Room Ebo 124 M 400V 50Hz - V:

Servicemanual

Baking chamber Ebo 124 M 400V 50Hz

Version:

Ident:

Series:

Part-Number:

Chapter

baking chamber lighting Ebo 124 M 400V 50Hz - V:

109231 -

109268 -

111296 - sealing rope

402698 - stone baking plate EBO124

X1640-001-054 - heating holder top

X1660-001-055 - heating holder top middle

Part:**Part-Number: 109231**

Part:**Part-Number: 109268**

Part: sealing rope**Part-Number: 111296**

length at EBO 128/124 with 320 chamber = 2,90 m; length at EBO 128/124 with 355 chamber = 3,00 m; length at EBO 64/68 with 320 chamber = 1,65 m; length at EBO 64/68 with 355 chamber = 1,85 m

Part: stone baking plate EBO124**Part-Number: 402698**

When cleaning the stone plate do not use abrasive cleaner. Use only clear water and soft cloths.

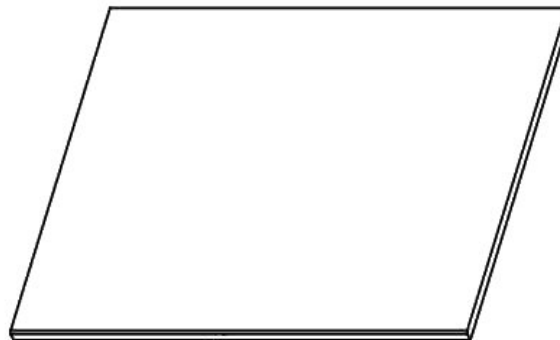
**Part: heating holder top****Part-Number: X1640-001-054**

Part: heating holder top middle**Part-Number: X1660-001-055**

Servicemanual

baking chamber lighting Ebo 124 M 400V 50Hz

Version:

Ident:

Series:

Part-Number:

Chapter

EX1660-001-065 - cover baking chamber lighting - V:

404835 - halogen lamp socket

42251 - screw

Part: halogen lamp socket

Part-Number: 404835

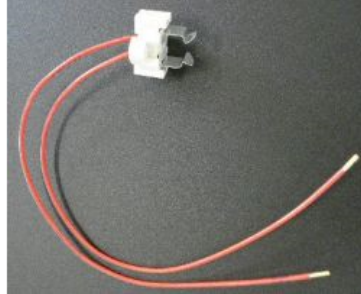

Part: screw

Part-Number: 42251



Servicemanual cover baking chamber lighting

Version:

Ident:

Series:

Part-Number: EX1660-001-065

Chapter

42251 - screw

70508 - Ebo frame for lamps-lower part

70509 - Ebo protective glass f. lamps-lower part

70510 - seal for bottom part of the lamp

Part: screw

Part-Number: 42251

**Part: Ebo frame for lamps-lower part**

Part-Number: 70508

**Part: Ebo protective glass f. lamps-lower part**

Part-Number: 70509

**Part: seal for bottom part of the lamp**

Part-Number: 70510



Service manual

Control Ebo 124 M 400V 50Hz

Version:

Ident:

Series:

Part-Number:

Chapter

107159 - female multipoint connector 2 pole
107160 - multi pin connector 3-pole
107161 - female multipoint connector 3 pole
107657 - spacer for circuit boards
109905 - through terminal, blue 2,5m
110525 - end clamp grey
111231 - spacer
111342 - multi pin connector
111343 - cross bridge iso. red 24 A 4/0
111345 - cable with plug for axial fan
33884 - relay main switch
36583 - ferrite core R3615X
401523 - loudspeaker
402662 - axial blower 19W heat resistance until 75°C
404699 - safety temperature limiter (UL) 360°C
404814 - intermediate plate clamp
9000-455-001 - drive fastener D10
9030-140-005 - thermocouple
9030-140-006 - thermo sensor
9030-320-004 - glass operating unit Exclusive Dibas/Ebo
9030-320-005 - glass operating unit Comfort Dibas/Ebo
9030-320-006 - glass operating unit Classic Dibas/Ebo
9030-320-011 - glass operating unit Classic nostalgia
9030-320-012 - glass operating unit Comfort nostalgia
9030-320-013 - glass operating unit Exclusive nostalgia
9030-330-001 - motherboard universal
9030-330-003 - terminal board active
9030-430-037 - data cable control Comfort-Classic
9030-430-112 - cable USB- extension 0,5m
9030-430-113 - USB-extension cord
9030-430-128 - supply line 5x2,5
9030-485-002 - ferrite ring 15,5
9520-510-001 - binder attachment
X1200-355-117 - fastener USB
X1660-350-010 - clamping frame
X1660-350-014 - cover control Exclusive
X1660-350-015 - cover control Comfort / Classic
X2200-353-053 - cover USB interface

Part: female multipoint connector 2 pole

Part-Number: 107159

Part: multi pin connector 3-pole

Part-Number: 107160

Part: female multipoint connector 3 pole

Part-Number: 107161

Part: spacer for circuit boards

Part-Number: 107657

**Part: through terminal, blue 2,5m**

Part-Number: 109905

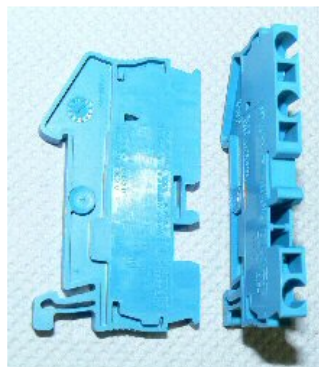

Part: end clamp grey

Part-Number: 110525

Part: spacer

Part-Number: 111231

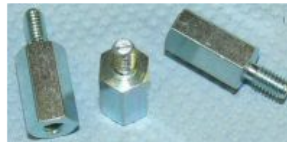
**Part: multi pin connector**

Part-Number: 111342

Part: cross bridge iso. red 24 A 4/0

Part-Number: 111343

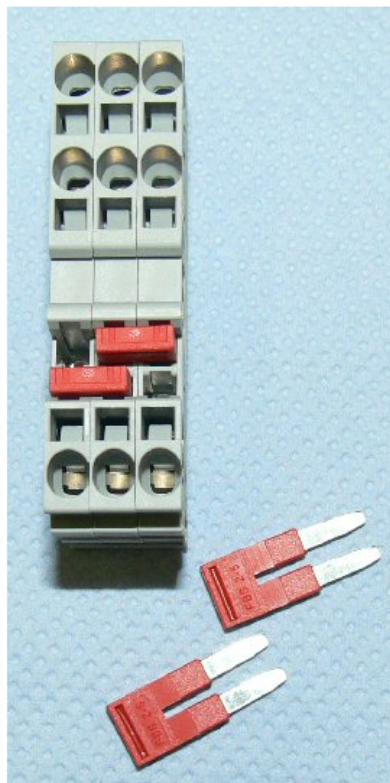

Part: cable with plug for axial fan

Part-Number: 111345



Part: relay main switch

Part-Number: 33884

The contactor switches the heater on/off.



Part: ferrite core R3615X

Part-Number: 36583



Part: loudspeaker

Part-Number: 401523

The loud speaker signal serves as an acoustic signal. For example notification is given for "temperature reached", "end of program". It is controlled by the circuit board.



Part: axial blower 19W heat resistance until 75°C

Part-Number: 402662

Axial fan to cool the electronic components. Heat resistant up to 75°C, marked with the letter "Z". The service uses as after-market equipment the axial fan, item no. 402661, heat resistant up to 85°C marked with the letter "N".



Part: safety temperature limiter (UL) 360°C

Part-Number: 404699

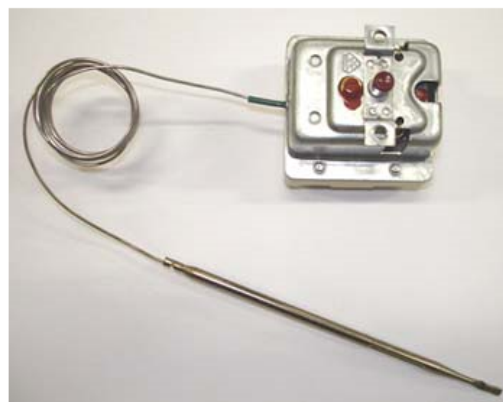

Part: intermediate plate clamp**Part-Number: 404814****Part: drive fastener D10****Part-Number: 9000-455-001****Part: thermocouple****Part-Number: 9030-140-005****Part: thermo sensor****Part-Number: 9030-140-006**

Part: glass operating unit Exclusive Dibas/Ebo

Part-Number: 9030-320-004



Part: glass operating unit Comfort Dibas/Ebo

Part-Number: 9030-320-005



Part: glass operating unit Classic Dibas/Ebo**Part-Number: 9030-320-006****Part: glass operating unit Classic nostalgia****Part-Number: 9030-320-011**

Part: glass operating unit Comfort nostalgia

Part-Number: 9030-320-012



Part: glass operating unit Exclusive nostalgia

Part-Number: 9030-320-013



Part: motherboard universal

Part-Number: 9030-330-001



Part: terminal board active

Part-Number: 9030-330-003

**Part: data cable control Comfort-Classic**

Part-Number: 9030-430-037

**Part: cable USB- extension 0,5m**

Part-Number: 9030-430-112

**Part: USB-extension cord**

Part-Number: 9030-430-113



Part: supply line 5x2,5**Part-Number: 9030-430-128**

Part: ferrite ring 15,5**Part-Number: 9030-485-002**

Part: binder attachment**Part-Number: 9520-510-001**

Part: fastener USB**Part-Number: X1200-355-117**

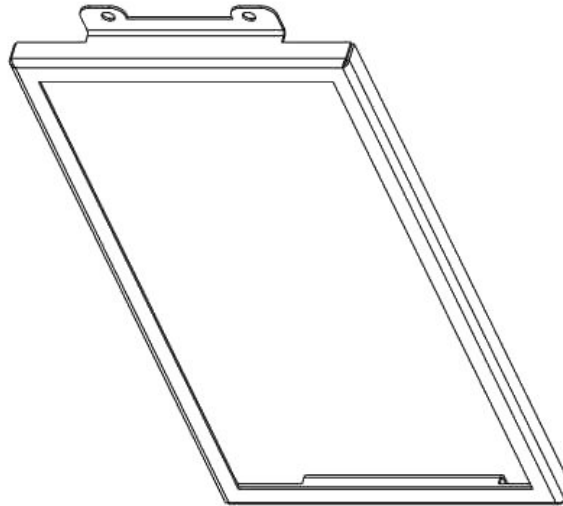
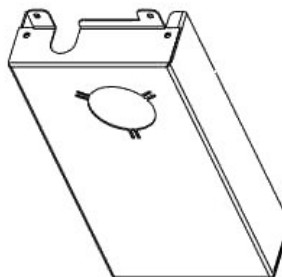
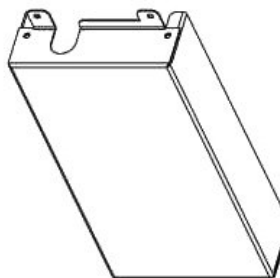
Part: clamping frame**Part-Number: X1660-350-010****Part: cover control Exclusive****Part-Number: X1660-350-014****Part: cover control Comfort / Classic****Part-Number: X1660-350-015**

Part: cover USB interface

Part-Number: X2200-353-053



Service manual

Door Ebo 124 M 400V 50Hz

Version:

Ident:

Series:

Part-Number:

Chapter

X1660-450-020 - Door lever Ebo 124 M 400V 50Hz - V:
X1660-450-010 - glass pane Ebo 124 M 400V 50Hz - V:

109163 - bearing shaft for window EBO
111229 - thread screw 6x25
111327 - bearing shaft for window, left assembled
400141 - contact switch door (MAN)
42283 - nut
42693 - screw M5 x 2,5 DIN923
9000-132-005 - screw DIN923 M6x4
X1660-450-002 - shaft

Part: bearing shaft for window EBO

Part-Number: 109163

Part: thread screw 6x25

Part-Number: 111229

Part: bearing shaft for window, left assembled

Part-Number: 111327

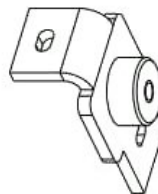
**Part: contact switch door (MAN)**

Part-Number: 400141

**Part: nut**

Part-Number: 42283



Part: screw M5 x 2,5 DIN923**Part-Number: 42693**

The left hangers is fastened in the baking chamber with screws.

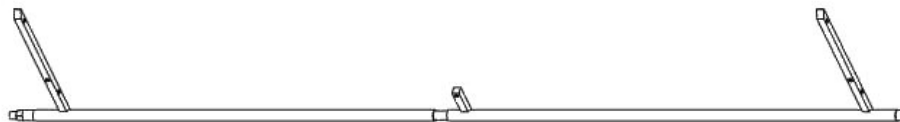
**Part: screw DIN923 M6x4****Part-Number: 9000-132-005****Part: shaft****Part-Number: X1660-450-002**

Servicemanual

Door lever Ebo 124 M 400V 50Hz

Version:

Ident:

Series:

Part-Number: X1660-450-020

Chapter

109322 - door lever welded EBO
109716 - bushing
110692 - hexagonal screw 8x50
110743 - hexagonal nut M8
111417 - screw
400765 - tension spring
42022 - washer
42073 - nut
70148 - door handle black
X1660-450-018 - spring hook

Part: door lever welded EBO

Part-Number: 109322



Part: bushing

Part-Number: 109716

Part: hexagonal screw 8x50

Part-Number: 110692



Part: hexagonal nut M8

Part-Number: 110743



Part: screw

Part-Number: 111417



Part: tension spring**Part-Number: 400765****Part: washer****Part-Number: 42022****Part: nut****Part-Number: 42073****Part: door handle black****Part-Number: 70148**

The door hinge is also available in "silver" or "gold" colour for the "nostalgy" version



Part: spring hook

Part-Number: X1660-450-018

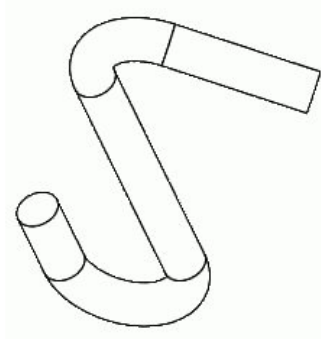

Service manual

glass pane Ebo 124 M 400V 50Hz

Version:

Ident:

Series:

Part-Number: X1660-450-010

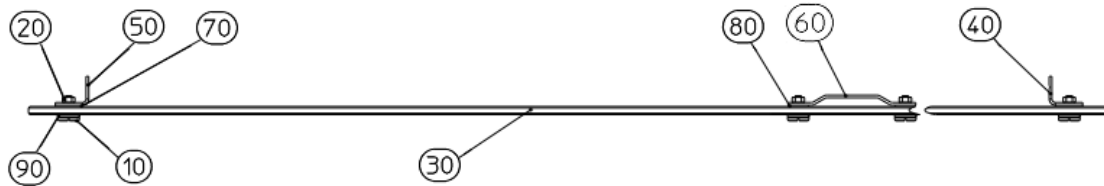

Chapter

- 9010-240-004 - thrust piece springy M6x15
- [010] - 9000-129-002 - screw M5 x 16
- [020] - 42034 - nut
- [030] - X1660-450-008 - glass pane M
- [040] - X1660-450-012 - door angle right M
- [050] - X1660-450-014 - door angle left M
- [060] - X1660-450-015 - door angle middle
- [070] - X1660-450-016 - silicone pad M
- [080] - X1660-450-017 - silicone pad middle
- [090] - X1702-460-011 - distance bush

Part: thrust piece springy M6x15

Part-Number: 9010-240-004

Part: screw M5 x 16

Part-Number: 9000-129-002

Part: nut

Part-Number: 42034

**Part: glass pane M**

Part-Number: X1660-450-008

Part: door angle right M

Part-Number: X1660-450-012

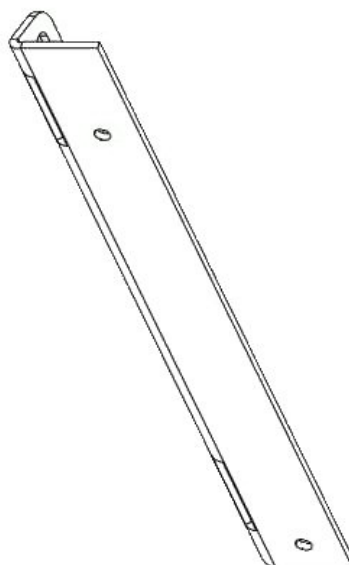

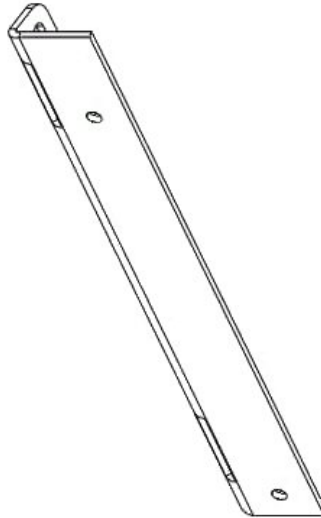
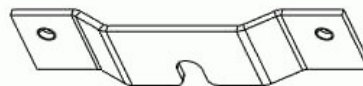
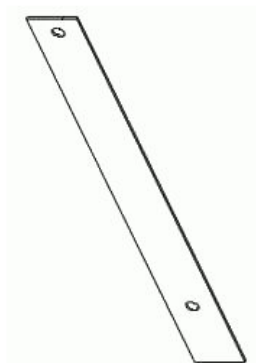
Part: door angle left M**Part-Number: X1660-450-014****Part: door angle middle****Part-Number: X1660-450-015****Part: silicone pad M****Part-Number: X1660-450-016**

Part: silicone pad middle

Part-Number: X1660-450-017

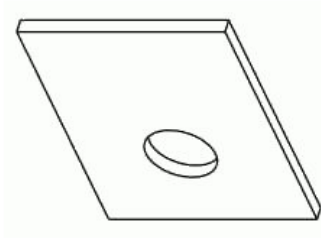

Part: distance bush

Part-Number: X1702-460-011

Service manual

Frame Ebo 124 M 400V 50Hz

Version:

Ident:

Series:

Part-Number: X1640-500-000

Chapter

EX1660-500-025 - frame right Ebo 124/128 M nostalgia, Ebo 124 M 400V 50Hz - V:

EX1660-500-024 - frame right Ebo 124/128 M, Ebo 124 M 400V 50Hz - V:

402169 - cap EBO cover light

X1640-500-002 - side panel left Ebo 124 M

X1640-500-003 - side panel left Ebo 124 M nostalgia

X1640-500-004 - side panel right Ebo 124 M

X1640-500-005 - side panel right Ebo 124 M nostalgia

X1660-500-010 - frame control spot-welded Ebo 124/128 M

X1660-500-011 - frame control spot-welded Ebo 124/128 M nostalgia

X1660-500-022 - rear panel Ebo 124/128 M

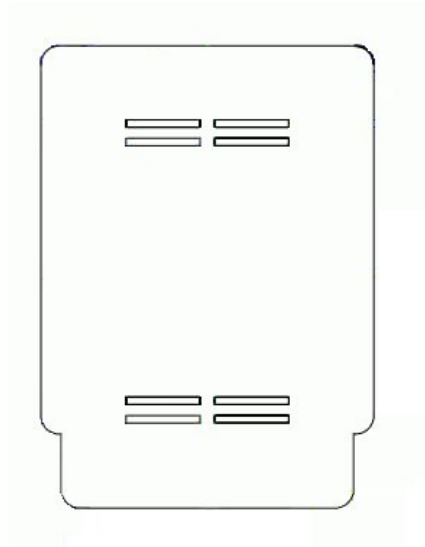
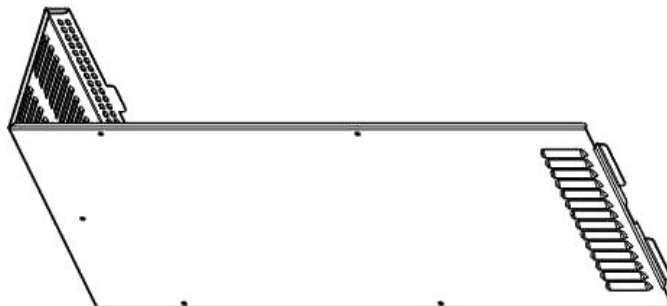
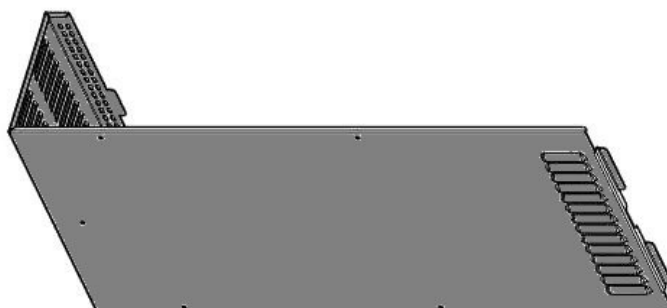
Part: cap EBO cover light**Part-Number: 402169****Part: side panel left Ebo 124 M****Part-Number: X1640-500-002****Part: side panel left Ebo 124 M nostalgia****Part-Number: X1640-500-003**

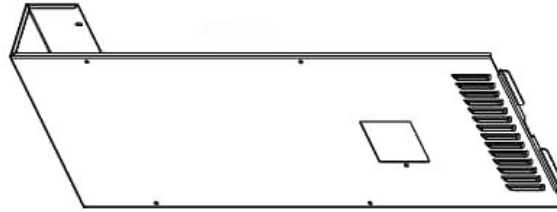
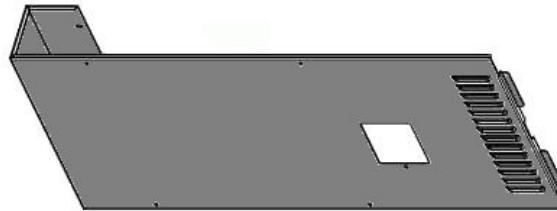
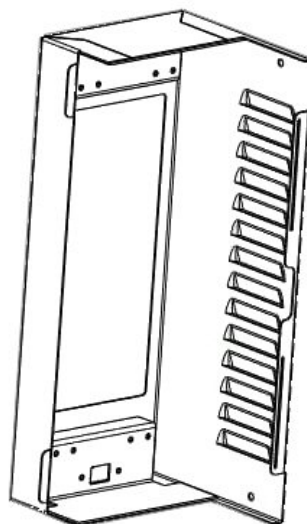
Part: side panel right Ebo 124 M**Part-Number: X1640-500-004****Part: side panel right Ebo 124 M nostalgia****Part-Number: X1640-500-005****Part: frame control spot-welded Ebo 124/128 M****Part-Number: X1660-500-010**

Part: frame control spot-welded Ebo 124/128 M nostalgia

Part-Number: X1660-500-011

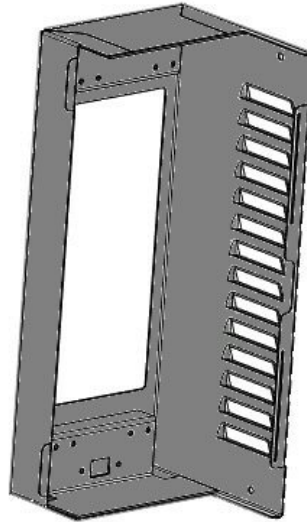

Part: rear panel Ebo 124/128 M

Part-Number: X1660-500-022

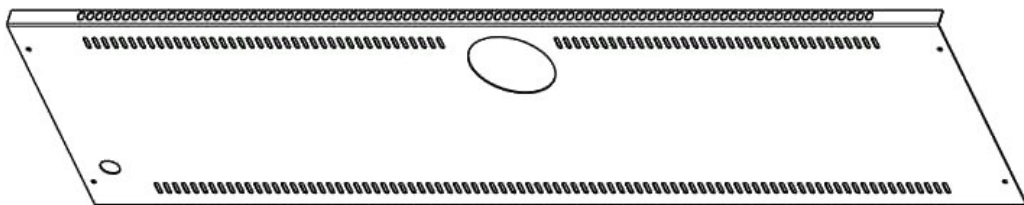

Servicemanual

frame right Ebo 124/128 M nostalgia, Ebo 124 M 400V 50Hz

Version:

Ident:

Series:

Part-Number: EX1660-500-025

Chapter

110218 - silicone foam square profile

X1660-500-013 - frame right spot-welded Ebo 124/128 M nostalgia

Part: silicone foam square profile

Part-Number: 110218

Part: frame right spot-welded Ebo 124/128 M nostalgia

Part-Number: X1660-500-013

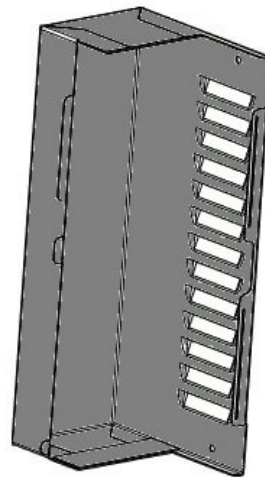

Servicemanual frame right Ebo 124/128 M, Ebo 124 M 400V 50Hz

Version:

Ident:

Series:

Part-Number: EX1660-500-024

Chapter

110218 - silicone foam square profile

X1660-500-012 - frame right spot-welded Ebo 124/128 M

Part: silicone foam square profile

Part-Number: 110218

Part: frame right spot-welded Ebo 124/128 M

Part-Number: X1660-500-012

Service manual Heater Ebo 124 M 400V 50Hz

Version:

Ident:

Series:

Part-Number:

Chapter

EX1660-300-020 - pipe heater 500W Ebo 124 M 400V 50Hz - V:

EX1660-300-021 - pipe heater 700W Ebo 124 M 400V 50Hz - V:

X1640-001-055 - heating holder top

Part: heating holder top

Part-Number: X1640-001-055

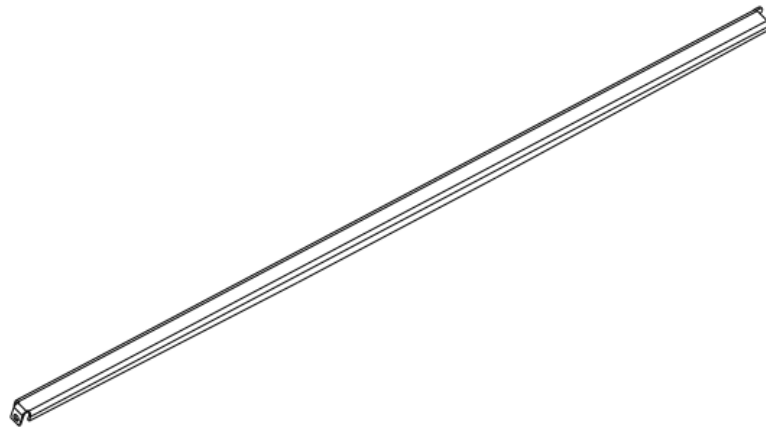

Service manual pipe heater 500W Ebo 124 M 400V 50Hz

Version:

Ident:

Series:

Part-Number: EX1660-300-020

Chapter

110567 - screw M6x16

202-65 - seal for pipe heater

42012 - washer

42201 - spring ring V2A M6

X1660-300-016 - pipe heating 500 W

Part: screw M6x16

Part-Number: 110567

Part: seal for pipe heater

Part-Number: 202-65

When changing the pipe heating, always replace the seal of the pipe heating.

**Part: washer**

Part-Number: 42012

**Part: spring ring V2A M6**

Part-Number: 42201

**Part: pipe heating 500 W**

Part-Number: X1660-300-016

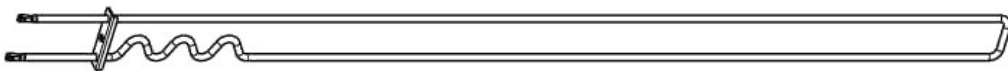

Service manual pipe heater 700W Ebo 124 M 400V 50Hz

Version:

Ident:

Series:

Part-Number: EX1660-300-021

Chapter

110567 - screw M6x16

202-65 - seal for pipe heater

42012 - washer

42201 - spring ring V2A M6

X1660-300-018 - pipe steaming 700W

Part: screw M6x16

Part-Number: 110567

Part: seal for pipe heater

Part-Number: 202-65

When changing the pipe heating, always replace the seal of the pipe heating.

**Part: washer**

Part-Number: 42012

**Part: spring ring V2A M6**

Part-Number: 42201

**Part: pipe steaming 700W**

Part-Number: X1660-300-018

Service manual

Installation Room Ebo 124 M 400V 50Hz

Version:

Ident:

Series:

Part-Number:

Chapter

Boiler Ebo 124 M 400V 50Hz - V:

condensate drain Ebo 124 M 400V 50Hz - V:

Exhaust Ebo 124 M 400V 50Hz - V:

exhaust piping Ebo 124 M 400V 50Hz - V:

water connection chambers (outside) Ebo 124 M 400V 50Hz - V:

Servicemanual

Boiler Ebo 124 M 400V 50Hz

Version:

Ident:

Series:

Part-Number:

Chapter

EX1640-200-015 - boiler BM Ebo 124 M 400V 50Hz - V:

X1640-200-000 - boiler standard Ebo 124 M 400V 50Hz - V:

EX1660-200-008 - steaming pipe Ebo 124 M 400V 50Hz - V:

X1660-200-021 - water inlet Classic Ebo 124 M 400V 50Hz - V:

X1660-200-020 - water inlet Comfort - Exclusive Ebo 124 M 400V 50Hz - V:

Servicemanual boiler BM Ebo 124 M 400V 50Hz

Version:

Ident:

Series:

Part-Number: EX1640-200-015

Chapter

109311 - isolation rear panel outside

109396 - isolation on the boiler

109397 - isolation under the boiler

109420 - between isolation boiler

X1640-200-000 - boiler standard

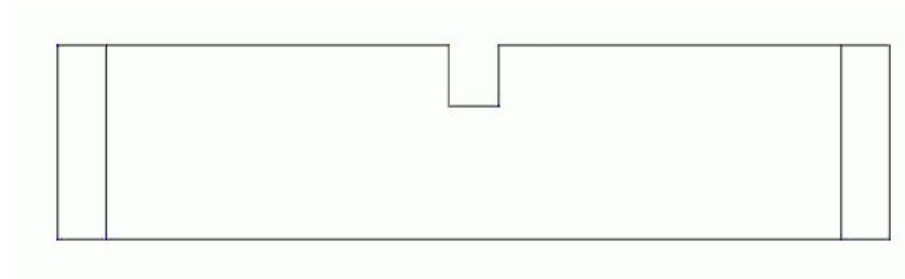
Part: isolation rear panel outside**Part-Number: 109311**

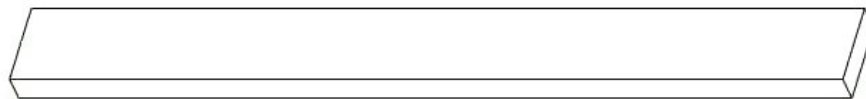
Part: isolation on the boiler**Part-Number: 109396**

Part: isolation under the boiler**Part-Number: 109397**

Part: between isolation boiler**Part-Number: 109420**

Part: boiler standard

Part-Number: X1640-200-000

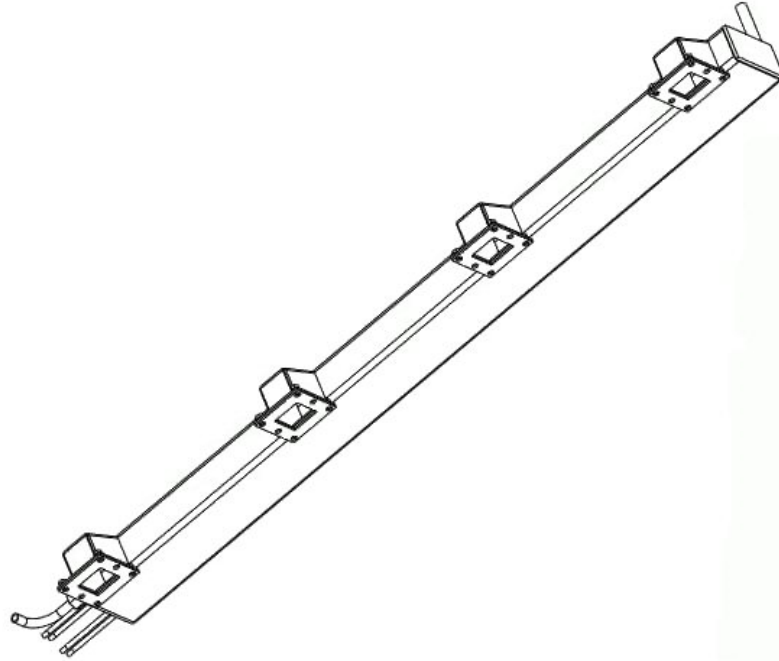

Servicemanual boiler standard Ebo 124 M 400V 50Hz

Version:

Ident:

Series:

Part-Number: X1640-200-000

Chapter

03617 - seal for steam generator
111126 - hex nut M6 DIN 934
240-96 - pipe heating EBO 124
42012 - washer
42201 - spring ring V2A M6
X1640-200-002 - boiler + steaming

Part: seal for steam generator

Part-Number: 03617

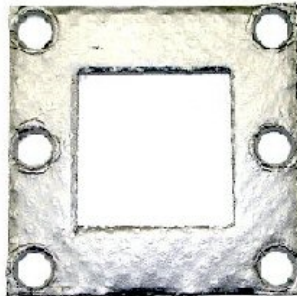

Part: hex nut M6 DIN 934

Part-Number: 111126



Part: pipe heating EBO 124

Part-Number: 240-96



Part: washer

Part-Number: 42012



Part: spring ring V2A M6

Part-Number: 42201



Part: boiler + steaming

Part-Number: X1640-200-002

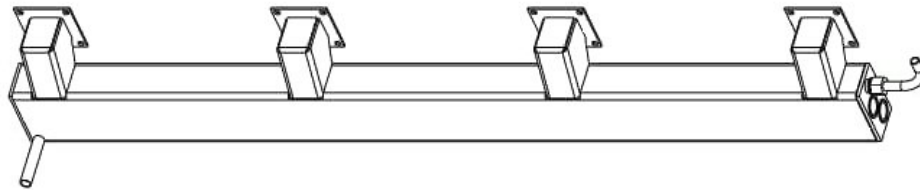

Servicemanual steaming pipe Ebo 124 M 400V 50Hz

Version:

Ident:

Series:

Part-Number: EX1660-200-008

Chapter

402933 - screwing

X1660-200-095 - steaming pipe

Part: screwing

Part-Number: 402933



Part: steaming pipe

Part-Number: X1660-200-095

Service manual water inlet Classic Ebo 124 M 400V 50Hz

Version:

Ident:

Series:

Part-Number: X1660-200-021

Chapter

111323 - Solenoid valve with angled 1 / 4 "thread

33524 - HT - hose silicone D 18xS3 LW12

42237 - hose clamp 12-22/9A1

Part: Solenoid valve with angled 1 / 4 "thread

Part-Number: 111323

Part: HT - hose silicone D 18xS3 LW12

Part-Number: 33524

**Part: hose clamp 12-22/9A1**

Part-Number: 42237



Servicemanual

water inlet Comfort - Exclusive Ebo 124 M 400V 50Hz

Version:

Ident:

Series:

Part-Number: X1660-200-020

Chapter

111323 - Solenoid valve with angled 1 / 4 "thread
33524 - HT - hose silicone D 18xS3 LW12
42237 - hose clamp 12-22/9A1
9060-115-001 - extansion -inside
9060-150-001 - hose nozzle female thread
9060-510-001 - flow meter

Part: Solenoid valve with angled 1 / 4 "thread

Part-Number: 111323

Part: HT - hose silicone D 18xS3 LW12

Part-Number: 33524

**Part: hose clamp 12-22/9A1**

Part-Number: 42237

**Part: extansion -inside**

Part-Number: 9060-115-001

**Part: hose nozzle female thread**

Part-Number: 9060-150-001



Part: flow meter

Part-Number: 9060-510-001



Service manual condensate drain Ebo 124 M 400V 50Hz

Version:

Ident:

Series:

Part-Number:

Chapter

111855 - condensate collector mounted
33524 - HT - hose silicone D 18xS3 LW12

Part: condensate collector mounted

Part-Number: 111855

Part: HT - hose silicone D 18xS3 LW12

Part-Number: 33524



Service manual Exhaust Ebo 124 M 400V 50Hz

Version:

Ident:

Series:

Part-Number:

Chapter

EX1660-250-010 - Exhaust box Ebo 124 M 400V 50Hz - V:

9020-700-004 - actuators EBO

X1660-250-002 - drive shaft welded

Part: actuators EBO

Part-Number: 9020-700-004

Part: drive shaft welded

Part-Number: X1660-250-002



Service manual

Exhaust box Ebo 124 M 400V 50Hz

Version:

Ident:

Series:

Part-Number: EX1660-250-010

Chapter

106063 - exhaust air box seal
111126 - hex nut M6 DIN 934
112181 - exhaust box mounted
42012 - washer
42201 - spring ring V2A M6
42500 - grub screw
917766 - clamping sleeve

Part: exhaust air box seal

Part-Number: 106063

Part: hex nut M6 DIN 934

Part-Number: 111126



Part: exhaust box mounted

Part-Number: 112181

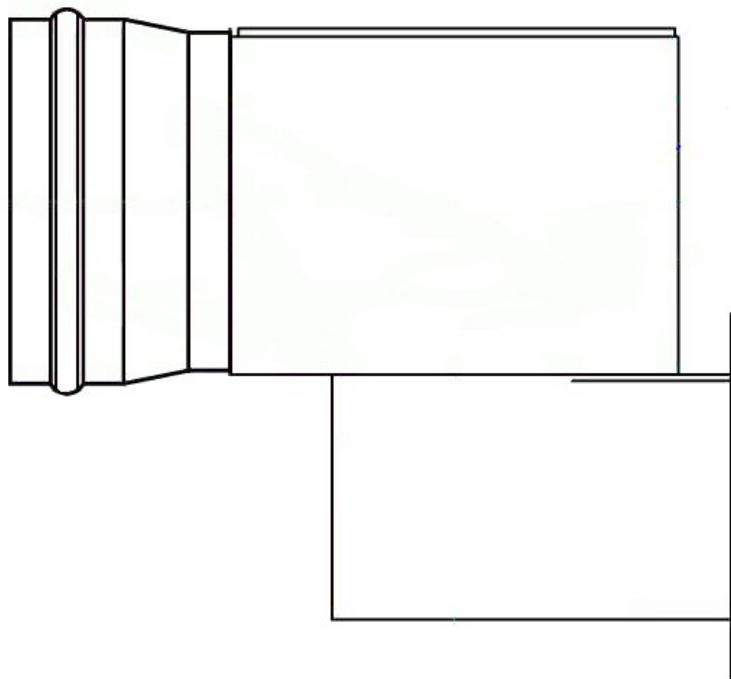

Part: washer**Part-Number: 42012**

Part: spring ring V2A M6**Part-Number: 42201**

Part: grube screw**Part-Number: 42500**

Part: clamping sleeve**Part-Number: 917766**

Service manual exhaust piping Ebo 124 M 400V 50Hz

Version:

Ident:

Series:

Part-Number:

Chapter

34310 - O-ring, silicone

X1660-205-010 - exhaust pipe M

X1660-205-020 - exhaust pipe M with condensate drain

Part: O-ring, silicone

Part-Number: 34310

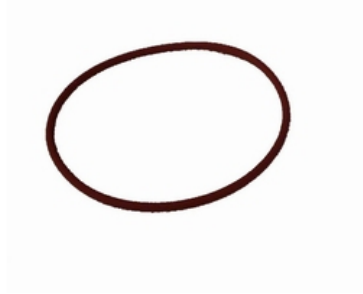

Part: exhaust pipe M

Part-Number: X1660-205-010

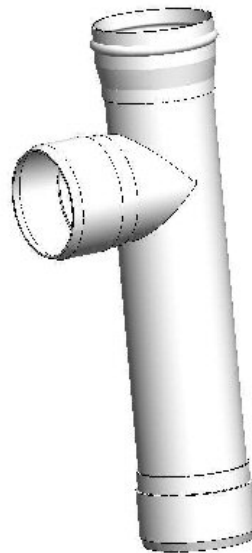

Part: exhaust pipe M with condensate drain

Part-Number: X1660-205-020

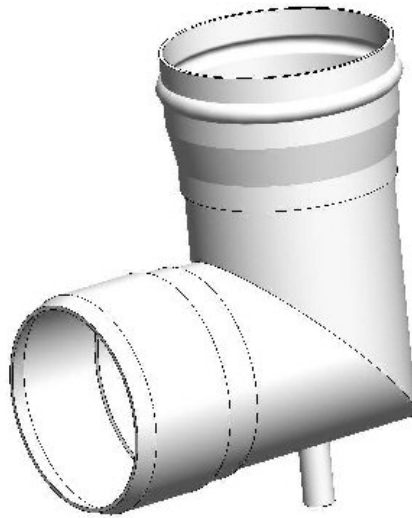

Service manual

water connection chambers (outside) Ebo 124 M 400V 50Hz

Version:

Ident:

Series:

Part-Number:

Chapter

403230 - elbow gland 1/4" Ø10

403231 - T-gland 1/4"

403232 - adapter 3/4" - 1/4"

403233 - plastic tube

403234 - circlip 3/8

Part: elbow gland 1/4" Ø10

Part-Number: 403230



Part: T-gland 1/4"

Part-Number: 403231



Part: adapter 3/4" - 1/4"

Part-Number: 403232



Part: plastic tube

Part-Number: 403233



Part: circlip 3/8

Part-Number: 403234

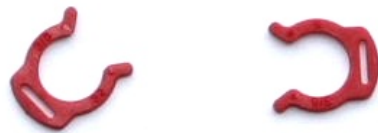

Urheberrecht:

Das Urheberrecht an diesem Servicehandbuch verbleibt bei der WIESHEU GmbH. Dieses Servicehandbuch ist nur für autorisierte Servicepartner und dessen Personal bestimmt. Sie enthält Vorschriften und Hinweise, die weder vollständig noch teilweise vervielfältigt, verbreitet oder anderweitig mitgeteilt werden dürfen.

Alle Darstellungen, Zeichnungen, Bilder Texte und Angaben sind urheberrechtlich geschützt. Sie unterliegen den gewerblichen Schutzrechten.

Zu diesem Servicehandbuch:

Alle Abbildungen in diesem Dokument sollen die Verständlichkeit unterstützen. Die Abbildungen sind nicht maßstabsgerecht. Teilweise sind dem Originalprodukt ähnelnde Abbildungen dargestellt, die geringfügig abweichen können.

Achtung!

Vermeiden Sie Fehlfunktionen oder Beschädigungen durch falsche Ersatzteile. Wir empfehlen die ausschließliche Verwendung von WIESHEU-Original-Ersatzteilen.

Wiesheu GmbH
Daimlerstrasse 10
DE-71563 Affalterbach
Telefon: +49 (0)7144 / 3 03-0
Fax: +49 (0)7144 / 3 03-11
Service-Telefon: 0800-WIESHEU
E-Mail: info@wiesheu.de
www.wiesheu.de

Stand: 7/5/2013